

# Astar

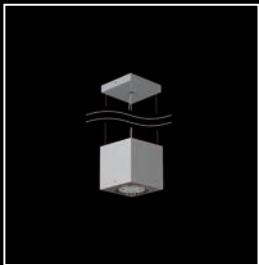

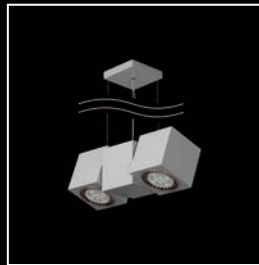

Astar T009B1W



Astar T009B2W

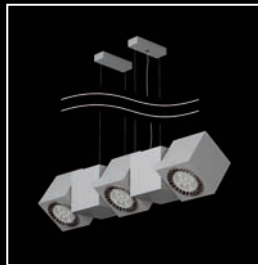

Astar T009B3W

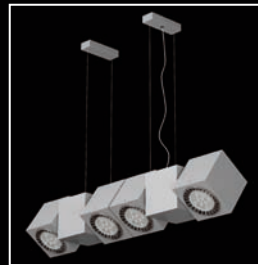

Astar T009B4W

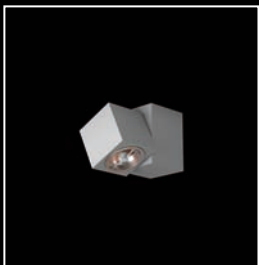

Astar T009D1S



Astar T009D2S

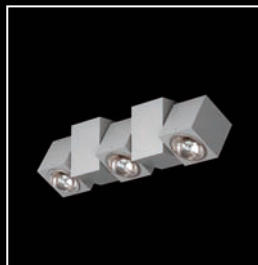

Astar T009D3S

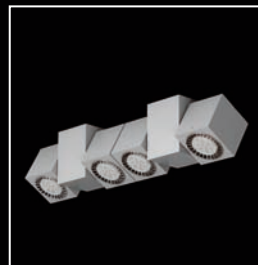

Astar T009D4S



Astar T009E1S

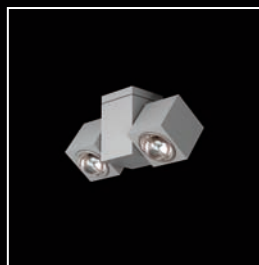

Astar T009E2S

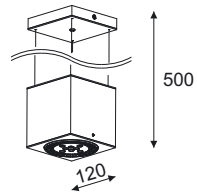

### Astar T009B1W



T009B1Wh ...color1



G53, 1 x max 100W, 12V, 50Hz



T009B1Wd ...color1



G53, 1 x max 20W, 12V, 50Hz, LED



T009B1Wm ...color1 ...power [W]



GX8,5, 1 x 20, 35, 70W, 230V, 50Hz

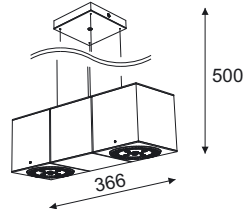
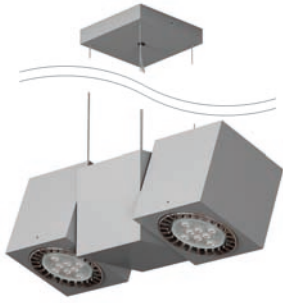

### Astar T009B2W



T009B2Wh ...color1



G53, 2 x max 100W, 12V, 50Hz



T009B2Wd ...color1



G53, 2 x max 20W, 12V, 50Hz, LED



T009B2Wm ...color1 ...power [W]



GX8,5, 2 x 20, 35, 70W, 230V, 50Hz

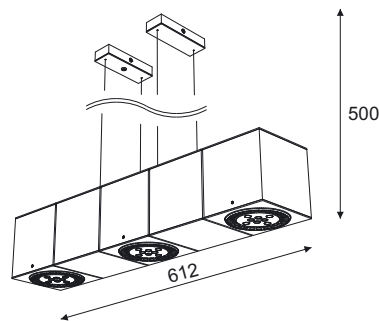
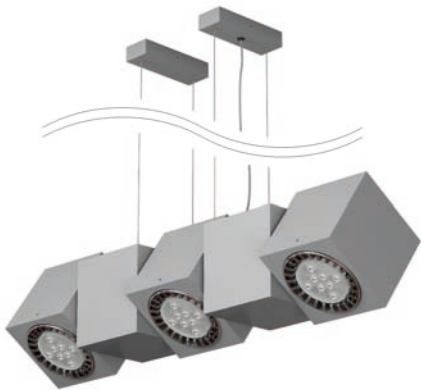

### Astar T009B3W



T009B3Wh ...color1



G53, 3 x max 100W, 12V, 50Hz



T009B3Wd ...color1



G53, 3 x max 20W, 12V, 50Hz, LED



T009B3Wm ...color1 ...power [W]



GX8,5, 3 x 20, 35, 70W, 230V, 50Hz

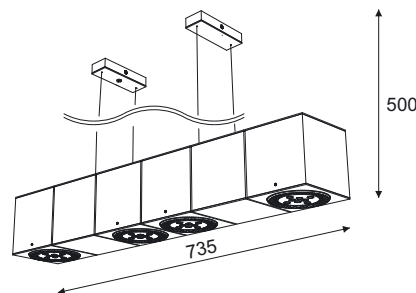
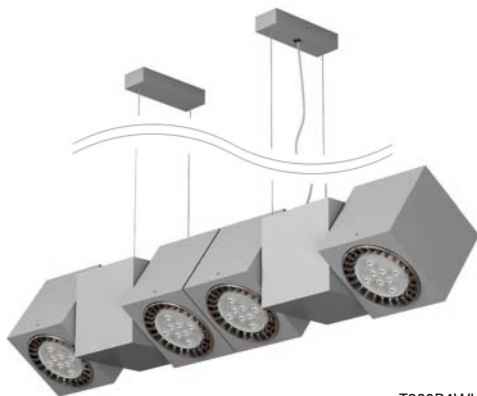
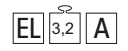

### Astar T009B4W



T009B4Wh ...color1



G53, 4 x max 100W, 12V, 50Hz



T009B4Wd ...color1



G53, 4 x max 20W, 12V, 50Hz, LED



T009B4Wm ...color1...power [W]



GX8,5, 4 x 20, 35, 70W, 230V, 50Hz



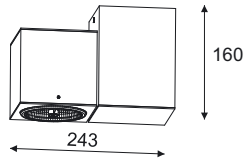

### Astar T009D1S



T009D1Sh ...color1



G53, 1 x max 100W, 12V, 50Hz



T009D1Sd ...color1



G53, 1 x max 20W, 12V, 50Hz, LED



T009D1Sm ...color1 ...power [W]



GX8,5, 1 x 20, 35, 70W, 230V, 50Hz

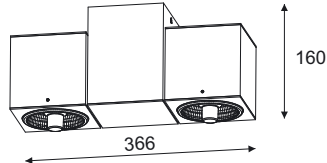

### Astar T009D2S



T009D2Sh ...color1



G53, 2 x max 100W, 12V, 50Hz



T009D2Sd ...color1



G53, 2 x max 20W, 12V, 50Hz, LED



T009D2Sm ...color1 ...power [W]



GX8,5, 2 x 20, 35, 70W, 230V, 50Hz

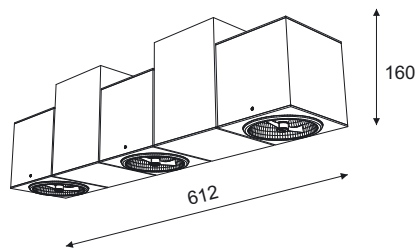

### Astar T009D3S



T009D3Sh ...color1



G53, 3 x max 100W, 12V, 50Hz



T009D3Sd ...color1



G53, 3 x max 20W, 12V, 50Hz, LED



T009D3Sm ...color1 ...power [W]



GX8,5, 3 x 20, 35, 70W, 230V, 50Hz

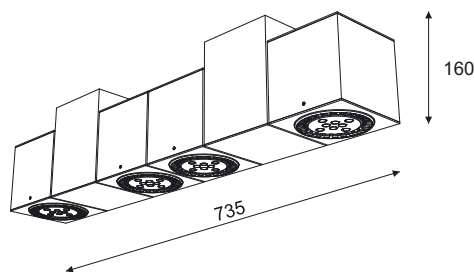
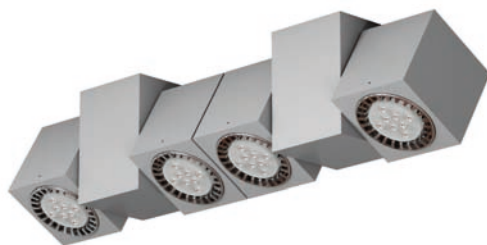
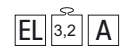

### Astar T009D4S



T009D4Sh ...color1



G53, 4 x max 100W, 12V, 50Hz

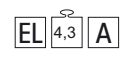

T009D4Sd ...color1



G53, 4 x max 20W, 12V, 50Hz, LED



T009D4Sm ...color1 ...power [W]



GX8,5, 4 x 20, 35, 70W, 230V, 50Hz



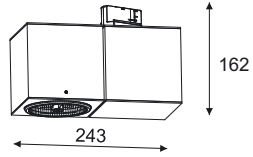

### Astar T009A1T



- T009A1Th ...color1
- T009A1Td ...color1
- T009A1Tm ...color1 ...power [W]



- G53, 1 x max 100W, 12V, 50Hz
- G53, 1 x max 20W, 12V, 50Hz, LED
- GX8,5, 1 x 20, 35, 70W, 230V, 50Hz

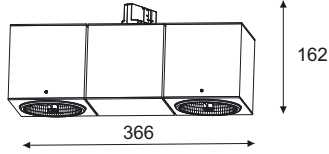
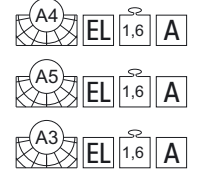

### Astar T009A2T



- T009A2Th ...color1
- T009A2Td ...color1
- T009A2Tm ...color1 ...power [W]



- G53, 2 x max 100W, 12V, 50Hz
- G53, 2 x max 20W, 12V, 50Hz, LED
- GX8,5, 2 x 20, 35, 70W, 230V, 50Hz

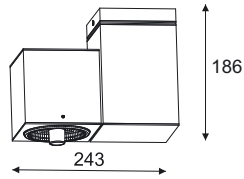
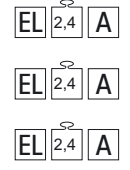

### Astar T009E1S



- T009E1Sh ...color1
- T009E1Sd ...color1
- T009E1Sm ...color1 ...power [W]



- G53, 1 x max 100W, 12V, 50Hz
- G53, 1 x max 20W, 12V, 50Hz, LED
- GX8,5, 1 x 20, 35, 70W, 230V, 50Hz

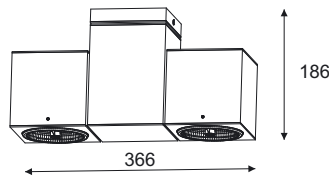
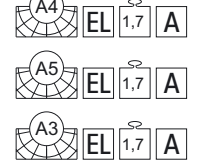

### Astar T009E2S



- T009E2Sh ...color1
- T009E2Sd ...color1
- T009E2Sm ...color1 ...power [W]



- G53, 2 x max 100W, 12V, 50Hz
- G53, 2 x max 20W, 12V, 50Hz, LED
- GX8,5, 2 x 20, 35, 70W, 230V, 50Hz

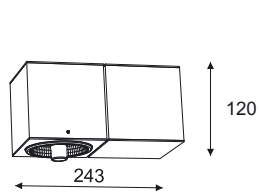
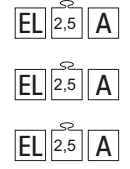

### Astar T009C1K kinkiet / wall lamp



- T009C1Kh ...color1
- T009C1Kd ...color1
- T009C1Km ...color1 ...power [W]



- G53, 1 x max 100W, 12V, 50Hz
- G53, 1 x max 20W, 12V, 50Hz, LED
- GX8,5, 1 x 20, 35, 70W, 230V, 50Hz

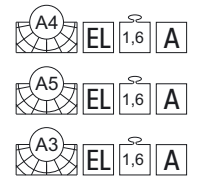

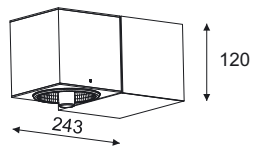

T009C2Kh ..color1  
 T009C2Kd ..color1  
 T009C2Km ...color1 ...power [W]

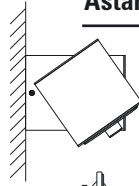

**Astar T009C2K kinkiet / wall lamp**



G53, 1 x max 100W, 12V, 50Hz



G53, 1 x max 20W, 12V, 50Hz, LED



GX8,5, 1 x 20, 35, 70W, 230V, 50Hz

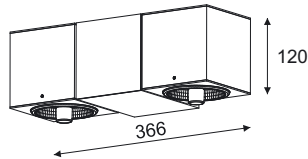

T009C3Kh ..color1  
 T009C3Kd ..color1  
 T009C3Km ...color1 ...power [W]

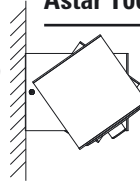

**Astar T009C3K kinkiet / wall lamp**



G53, 2 x max 100W, 12V, 50Hz



G53, 2x max 20W, 12V, 50Hz, LED



GX8,5, 2 x 20, 35, 70W, 230V, 50Hz

