

Producent **O**sprzętu Elektroinstalacyjnego

# SYSTEM RAMKOWY

u l o t k a   t e c h n i c z n a



## Vena



Piękno wkomponowane w system

**KOS**  
25 LAT RAZEM

# ■ Łączniki instalacyjne

## ■ Łączniki instalacyjne z klawiszem, bez ramki



Nazwa i dane znamionowe

Łącznik pojedynczy bez ramki, 16AX, 250V~

kolor: biały	kolor: kremowy	kolor: satyna	kolor: aluminium	kolor: patyna
Nr katalogowy 5104 11	Nr katalogowy 5103 11	Nr katalogowy 5150 11	Nr katalogowy 5140 11	Nr katalogowy 5130 11



Nazwa i dane znamionowe

Przycisk "światło" bez ramki, 10AX, 250V~

kolor: biały	kolor: kremowy	kolor: satyna	kolor: aluminium	kolor: patyna
Nr katalogowy 5104 13	Nr katalogowy 5103 13	Nr katalogowy 5150 13	Nr katalogowy 5140 13	Nr katalogowy 5130 13



Nazwa i dane znamionowe

Przycisk "dzwonek" bez ramki, 10AX, 250V~

kolor: biały	kolor: kremowy	kolor: satyna	kolor: aluminium	kolor: patyna
Nr katalogowy 5104 14	Nr katalogowy 5103 14	Nr katalogowy 5150 14	Nr katalogowy 5140 14	Nr katalogowy 5130 14



Nazwa i dane znamionowe

Łącznik świecznikowy bez ramki, 16AX, 250V~

kolor: biały	kolor: kremowy	kolor: satyna	kolor: aluminium	kolor: patyna
Nr katalogowy 5104 15	Nr katalogowy 5103 15	Nr katalogowy 5150 15	Nr katalogowy 5140 15	Nr katalogowy 5130 15

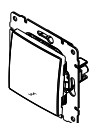

Nazwa i dane znamionowe

Łącznik schodowy bez ramki, 16AX, 250V~

kolor: biały	kolor: kremowy	kolor: satyna	kolor: aluminium	kolor: patyna
Nr katalogowy 5104 16	Nr katalogowy 5103 16	Nr katalogowy 5150 16	Nr katalogowy 5140 16	Nr katalogowy 5130 16



Nazwa i dane znamionowe

Łącznik krzyżowy bez ramki, 16AX, 250V~

kolor: biały	kolor: kremowy	kolor: satyna	kolor: aluminium	kolor: patyna
Nr katalogowy 5104 17	Nr katalogowy 5103 17	Nr katalogowy 5150 17	Nr katalogowy 5140 17	Nr katalogowy 5130 17

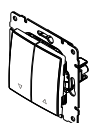

Nazwa i dane znamionowe

Łącznik żaluzjowy bez ramki, 16AX, 250V~

kolor: biały	kolor: kremowy	kolor: satyna	kolor: aluminium	kolor: patyna
Nr katalogowy 5104 18	Nr katalogowy 5103 18	Nr katalogowy 5150 18	Nr katalogowy 5140 18	Nr katalogowy 5130 18



Nazwa i dane znamionowe

Ściemniacz (122) - sterownik oświetlenia, sterowanie klawiszem i dowolnym pilotem, możliwość programowania działania na wybrany przycisk pilota, symulacji obecności, samoczynnego wygaszania światła, 40-400W

kolor: biały	kolor: kremowy	kolor: satyna	kolor: aluminium	kolor: patyna
Nr katalogowy 5104 62	Nr katalogowy 5103 62	Nr katalogowy 5150 62	Nr katalogowy 5140 62	Nr katalogowy 5130 62

## ■ Akcesoria

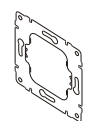

Nazwa i dane znamionowe

Element hermetyzujący

(podnosi stopień bryzgoszczelności łączników serii Vena do IP44)

kolor: transparentny
Nr katalogowy 5112 80



Nazwa i dane znamionowe

Element podświetlający (do łączników i przycisków serii Vena)

kolor: pomarańczowy
Nr katalogowy 5112 99

## ■ Montaż

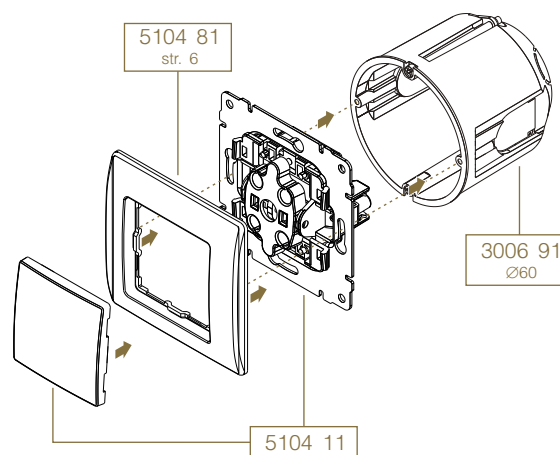

Piękno wkomponowane w system



Łącznik pojedynczy



Vena - natchnienie twórcze, radość tworzenia, werwa, powodzenie, szczęście\*

\* - Władysław Kopaliński; "Słownik wyrazów obcych i obcojęzycznych"

# Gniazda

## Gniazda wtyczkowe bez ramki

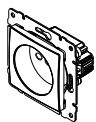

Nazwa i dane znamionowe

Gniazdo poj. 2P z przesłoną torów prądowych, bez ramki, 16A, 250V~



kolor: biały

Nr katalogowy 5104 33



kolor: kremowy

Nr katalogowy 5103 33



kolor: satyna

Nr katalogowy 5150 33



kolor: aluminium

Nr katalogowy 5140 33



kolor: patyna

Nr katalogowy 5130 33

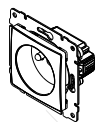

Nazwa i dane znamionowe

Gniazdo poj. 2P +Z z przesłoną torów prądowych, bez ramki, 16A, 250V~



kolor: biały

Nr katalogowy 5104 34



kolor: kremowy

Nr katalogowy 5103 34



kolor: satyna

Nr katalogowy 5150 34



kolor: aluminium

Nr katalogowy 5140 34



kolor: patyna

Nr katalogowy 5130 34

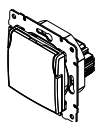

Nazwa i dane znamionowe

Gniazdo brygoszczelne poj. 2P+Z, z przesłoną torów prądowych, bez ramki, 16A, 250V~, IP44



kolor: biały

Nr katalogowy 5104 39



kolor: kremowy

Nr katalogowy 5103 39



kolor: satyna

Nr katalogowy 5150 39



kolor: aluminium

Nr katalogowy 5140 39



kolor: patyna

Nr katalogowy 5130 39



Nazwa i dane znamionowe

Gniazdo podwójne 2x2P, 16A, 250V~



kolor: biały

Nr katalogowy 5104 35



kolor: kremowy

Nr katalogowy 5103 35



kolor: satyna

Nr katalogowy 5150 35



kolor: aluminium

Nr katalogowy 5140 35



kolor: patyna

Nr katalogowy 5130 35



Nazwa i dane znamionowe

Gniazdo podwójne 2x2P+Z, 16A, 250V~



kolor: biały

Nr katalogowy 5104 36



kolor: kremowy

Nr katalogowy 5103 36



kolor: satyna

Nr katalogowy 5150 36



kolor: aluminium

Nr katalogowy 5140 36



kolor: patyna

Nr katalogowy 5130 36

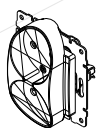

Nazwa i dane znamionowe

Gniazdo podwójne bez ramki 2x2P, 16A, 250V~



kolor: biały

Nr katalogowy 5104 46



kolor: kremowy

Nr katalogowy 5103 46



kolor: satyna

Nr katalogowy 5150 46



kolor: aluminium

Nr katalogowy 5140 46



kolor: patyna

Nr katalogowy 5130 46

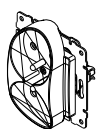

Nazwa i dane znamionowe

Gniazdo podwójne bez ramki 2x2P+Z, 16A, 250V~



kolor: biały

Nr katalogowy 5104 47



kolor: kremowy

Nr katalogowy 5103 47



kolor: satyna

Nr katalogowy 5150 47



kolor: aluminium

Nr katalogowy 5140 47



kolor: patyna

Nr katalogowy 5130 47

Nowoczesny design



Gniazdo pojedyncze

## Gniazda głośnikowe i antenowe, bez ramki



Nazwa i dane znamionowe

Gniazdo głośnikowe pojedyncze, stereofoniczne



kolor: biały

Nr katalogowy 5104 72



kolor: kremowy

Nr katalogowy 5103 72



kolor: satyna

Nr katalogowy 5150 72



kolor: aluminium

Nr katalogowy 5140 72



kolor: patyna

Nr katalogowy 5130 72

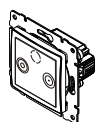

Nazwa i dane znamionowe

Gniazdo antenowe RTV końcowe, bez ramki, TV: 0,3 dB, R: 0,6 dB



kolor: biały

Nr katalogowy 5104 73



kolor: kremowy

Nr katalogowy 5103 73



kolor: satyna

Nr katalogowy 5150 73



kolor: aluminium

Nr katalogowy 5140 73



kolor: patyna

Nr katalogowy 5130 73

## ■ Gniazda teleinformatyczne bez ramki

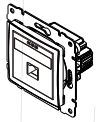

Nazwa i dane znamionowe

Gniazdo telefoniczne RJ11 pojedyncze, bez ramki, z etykietą

				
kolor: biały	kolor: kremowy	kolor: satyna	kolor: aluminium	kolor: patyna
Nr katalogowy 5104 63	Nr katalogowy 5103 63	Nr katalogowy 5150 63	Nr katalogowy 5140 63	Nr katalogowy 5130 63



Nazwa i dane znamionowe

Gniazdo telefoniczne RJ11 podwójne, bez ramki, z etykietą

				
kolor: biały	kolor: kremowy	kolor: satyna	kolor: aluminium	kolor: patyna
Nr katalogowy 5104 64	Nr katalogowy 5103 64	Nr katalogowy 5150 64	Nr katalogowy 5140 64	Nr katalogowy 5130 64



Nazwa i dane znamionowe

Gniazdo komputerowe RJ45, kat. 5e, nieekranowane, bez ramki, z przesłoną i etykietą

				
kolor: biały	kolor: kremowy	kolor: satyna	kolor: aluminium	kolor: patyna
Nr katalogowy 5104 65	Nr katalogowy 5103 65	Nr katalogowy 5150 65	Nr katalogowy 5140 65	Nr katalogowy 5130 65



Nazwa i dane znamionowe

Gniazdo komputerowe podwójne RJ45, kat. 5e, nieekranowane, bez ramki, z przesłoną

				
kolor: biały	kolor: kremowy	kolor: satyna	kolor: aluminium	kolor: patyna
Nr katalogowy 5104 67	Nr katalogowy 5103 67	Nr katalogowy 5150 67	Nr katalogowy 5140 67	Nr katalogowy 5130 67

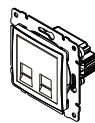

Nazwa i dane znamionowe

Gniazdo telefoniczno-komputerowe, RJ45 kat. 5e, nieekranowane z przesłoną + RJ11, bez ramki

				
kolor: biały	kolor: kremowy	kolor: satyna	kolor: aluminium	kolor: patyna
Nr katalogowy 5104 69	Nr katalogowy 5103 69	Nr katalogowy 5150 69	Nr katalogowy 5140 69	Nr katalogowy 5130 69



## ■ Akcesoria

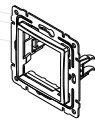

Nazwa i dane znamionowe

Uchwyt do instalacji modułów 45x45, z redukcją ramki

				
kolor: biały	kolor: kremowy	kolor: satyna	kolor: aluminium	kolor: patyna
Nr katalogowy 5104 45	Nr katalogowy 5103 45	Nr katalogowy 5150 45	Nr katalogowy 5140 45	Nr katalogowy 5130 45

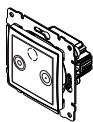

## ■ Montaż

## Najwyższa jakość



Nazwa i dane znamionowe

Gniazdo antenowe RTV przelotowe, bez ramki, TV: 8 dB, R: 8 dB

				
kolor: biały	kolor: kremowy	kolor: satyna	kolor: aluminium	kolor: patyna
Nr katalogowy 5104 74	Nr katalogowy 5103 74	Nr katalogowy 5150 74	Nr katalogowy 5140 74	Nr katalogowy 5130 74

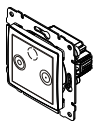

Nazwa i dane znamionowe

Gniazdo antenowe RTV przelotowe, bez ramki, TV: 13 dB, R: 13 dB

				
kolor: biały	kolor: kremowy	kolor: satyna	kolor: aluminium	kolor: patyna
Nr katalogowy 5104 75	Nr katalogowy 5103 75	Nr katalogowy 5150 75	Nr katalogowy 5140 75	Nr katalogowy 5130 75

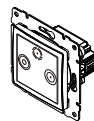

Nazwa i dane znamionowe

Gniazdo antenowe RTV SAT końcowe, bez ramki, TV: 0,5 dB, R: 0,5 Db, F: 1,5dB

				
kolor: biały	kolor: kremowy	kolor: satyna	kolor: aluminium	kolor: patyna
Nr katalogowy 5104 76	Nr katalogowy 5103 76	Nr katalogowy 5150 76	Nr katalogowy 5140 76	Nr katalogowy 5130 76

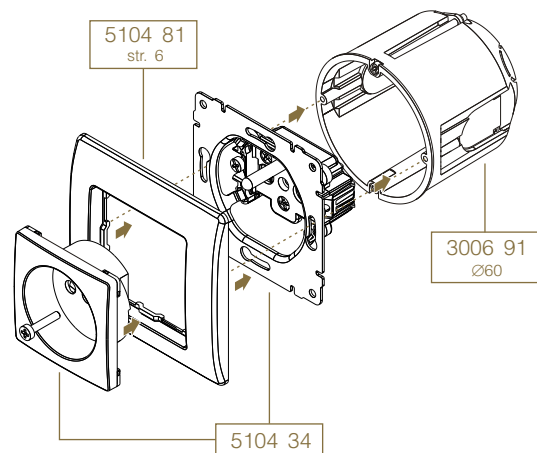

## Ramki

## Ramki instalacyjne

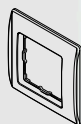

Nazwa i dane znamionowe

### Ramka 1x



kolor: biały

Nr katalogowy  
5104 81



kolor: kremowy

Nr katalogowy  
5103 81



kolor: satyna

Nr katalogowy  
5150 81



kolor: aluminium

Nr katalogowy  
5140 81



kolor: patyna

Nr katalogowy  
5130 81

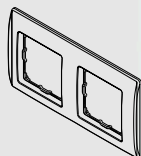

Nazwa i dane znamionowe

### Ramka 2x



kolor: biały

Nr katalogowy  
5104 82



kolor: kremowy

Nr katalogowy  
5103 82



kolor: satyna

Nr katalogowy  
5150 82



kolor: aluminium

Nr katalogowy  
5140 82



kolor: patyna

Nr katalogowy  
5130 82

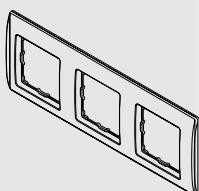

Nazwa i dane znamionowe

### Ramka 3x



kolor: biały

Nr katalogowy  
5104 83



kolor: kremowy

Nr katalogowy  
5103 83



kolor: satyna

Nr katalogowy  
5150 83



kolor: aluminium

Nr katalogowy  
5140 83



kolor: patyna

Nr katalogowy  
5130 83

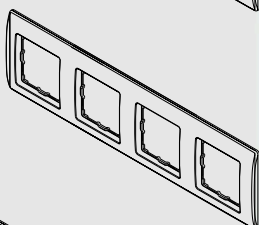

Nazwa i dane znamionowe

### Ramka 4x



kolor: biały

Nr katalogowy  
5104 84



kolor: kremowy

Nr katalogowy  
5103 84



kolor: satyna

Nr katalogowy  
5150 84



kolor: aluminium

Nr katalogowy  
5140 84



kolor: patyna

Nr katalogowy  
5130 84

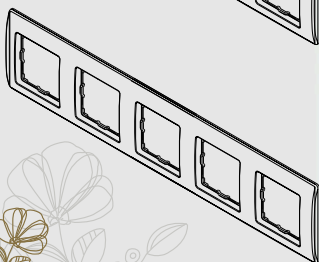

Nazwa i dane znamionowe

### Ramka 5x



kolor: biały

Nr katalogowy  
5104 85



kolor: kremowy

Nr katalogowy  
5103 85



kolor: satyna

Nr katalogowy  
5150 85



kolor: aluminium

Nr katalogowy  
5140 85



kolor: patyna

Nr katalogowy  
5130 85

## Oryginalne wzornictwo



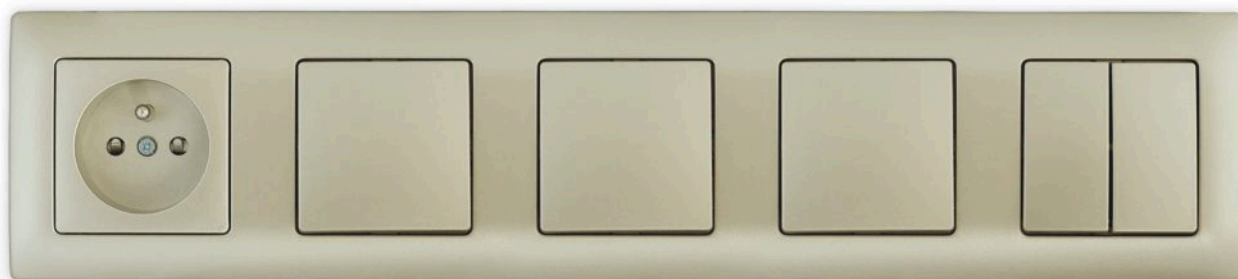

Ramki wielokrotne w dowolnym układzie



Wygoda montażu



Piękno w komponowane w system

[www.kos.pl](http://www.kos.pl)



**KOS Elektro System Sp. z o.o.**  
62-300 Września, ul. Wrocławska 43  
tel. (061) 438 65 29, fax (061) 438 63 60 Sekretariat: [kos@kos.pl](mailto:kos@kos.pl)  
Dział handlowy: (061) 640 36 71-72, [centrala@kos.pl](mailto:centrala@kos.pl)

Autoryzowany dystrybutor: