

# MIKRUS S

MINIATURE LOW - VOLTAGE LIGHTING SYSTEM  
MINIATUROWY NISKONAPIĘCIOWY SYSTEM OŚWIETLENIOWY



# MIKRUS S

- great flexibility and possibility of individual settings works perfectly in jewelry showcases, museum exhibitions, libraries etc.
  - the system consists of lighting track from high-quality material, spotlights (LED and halogen) and accessories for assembly and power supply.
  - LED light sources have very good light parameters - high color fidelity.
  - assembly or disassembly is possible without tools.
- duża swoboda ustawienia i modyfikacji scen oświetleniowych sprawdzi się doskonale w gablotach jubilerskich, ekspozycjach muzealnych, bibliotekach itp.
  - w skład systemu wchodzi szynoprzewody z wysokiej jakości tworzywa, reflektorki (LED i halogen) oraz akcesoria do łączenia i zasilania.
  - użyte źródła LED charakteryzują się dobrymi parametrami świetlnymi - wysokim odwzorowaniem kolorów.
  - montaż i demontaż punktów świetlnych jest możliwy bez użycia narzędzi.

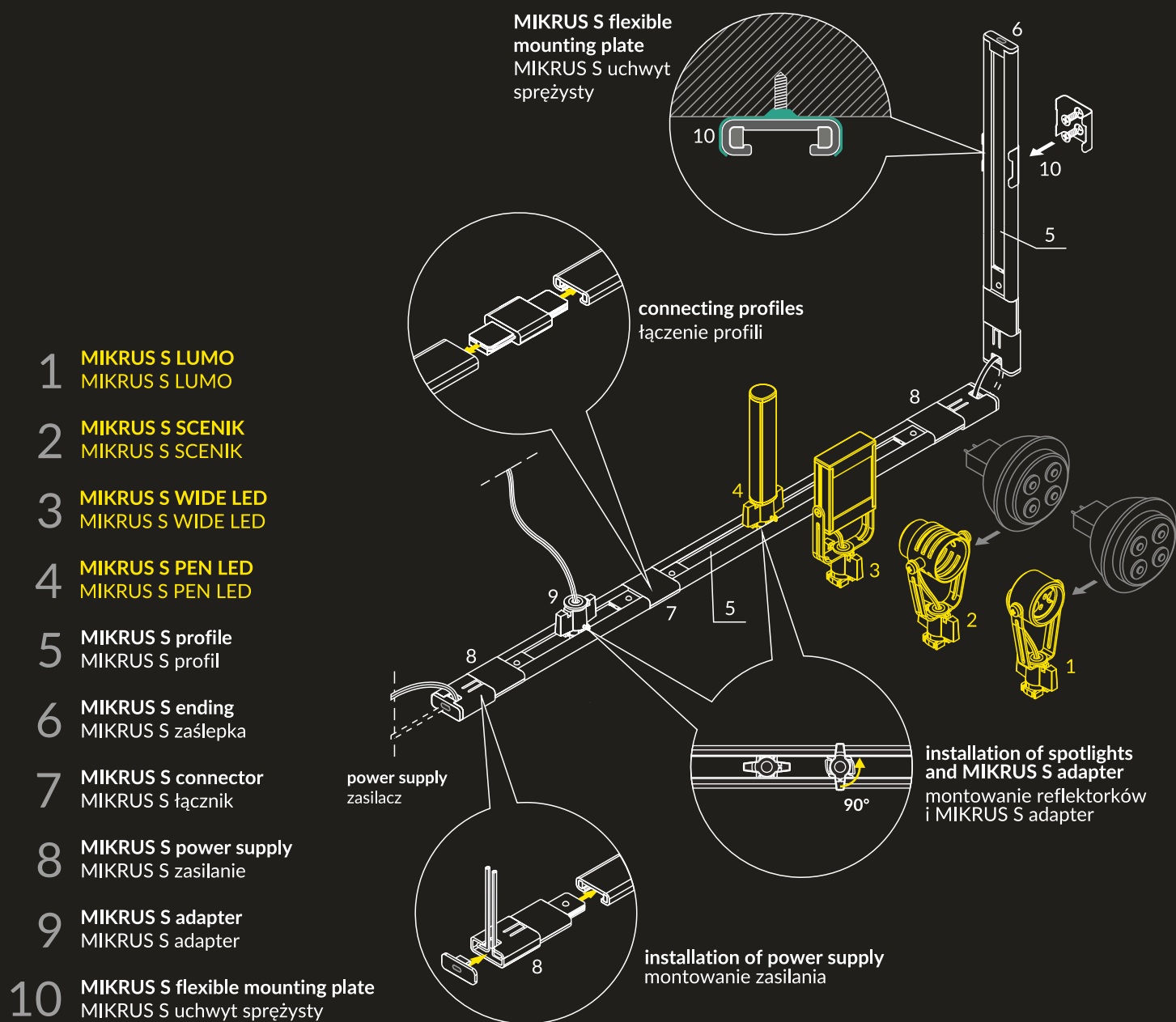

# LUMINAIRES OPRAWY

## MIKRUS S LUMO



light source not included  
brak źródła światła w komplecie

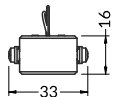
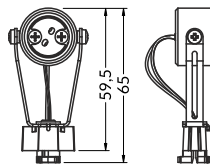

product	cap	input voltage	power	chrome
produkt	trzonek	napięcie	moc	chrom
MIKRUS S LUMO	GU5,3	12 V	20 W	94170103

## MIKRUS S WIDE LED



light source included  
źródło światła w komplecie

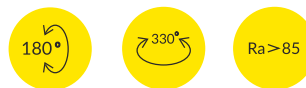
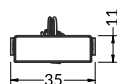
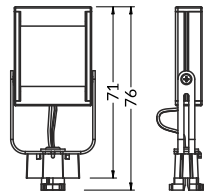

In luminaire MIKRUS S WIDE LED the CITIZEN 1,5 W LED light source was used - replacement for 10 W halogen lamp. W oprawie MIKRUS S WIDE LED zastosowano źródła LED firmy Citizen o mocy 1,5 W - zamiennik 10 W żarówki halogenowej.

product	lumen output	colour temperature	input voltage	power	silver
produkt	strumień świetlny	temperatura barwowa	napięcie	moc	srebro
MIKRUS S WIDE LED	106 lm	2700 K	12 V	1,5 W	94090622
MIKRUS S WIDE LED	110 lm	3000 K	12 V	1,5 W	94100622
MIKRUS S WIDE LED	115 lm	4000 K	12 V	1,5 W	94110622

## MIKRUS S PEN LED



light source included  
źródło światła w komplecie

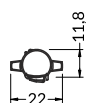
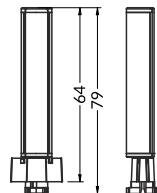

product	lumen output	colour temperature	input voltage	power	silver
produkt	strumień świetlny	temperatura barwowa	napięcie	moc	srebro
MIKRUS S PEN LED	140 lm	2700 K	12 V	1,5 W	94160320
MIKRUS S PEN LED	140 lm	3000 K	12 V	1,5 W	94140320
MIKRUS S PEN LED	148 lm	4000 K	12 V	1,5 W	94150320

## MIKRUS S SCENIK



light source not included  
brak źródła światła w komplecie

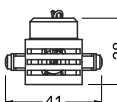
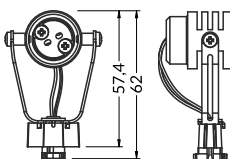

product	cap	input voltage	power	chrome
produkt	trzonek	napięcie	moc	chrom
MIKRUS S SCENIK	GU5,3	12 V	35 W	94080103

### MIKRUS S profile • MIKRUS S profil

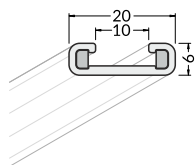

length transparent  
długość transparentny

500	94010000
1000	94020000
2000	94030000

### MIKRUS S ending • MIKRUS S zaślepka

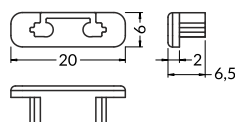

INDEX for 1 pc  
INDEKS = 1 szt

transparent  
transparentny

94050000

### MIKRUS S power supply • MIKRUS S zasilanie

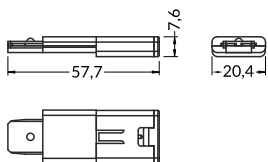
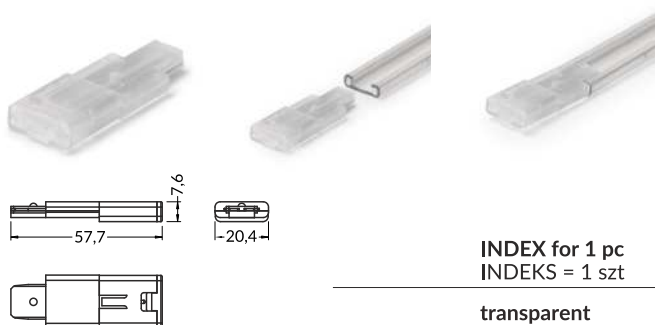

INDEX for 1 pc  
INDEKS = 1 szt

transparent  
transparentny

94040000

### MIKRUS S connector I • MIKRUS S łącznik I

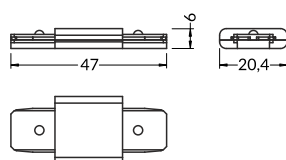

INDEX for 1 pc  
INDEKS = 1 szt

transparent  
transparentny

94060000

### MIKRUS S adapter • MIKRUS S adapter

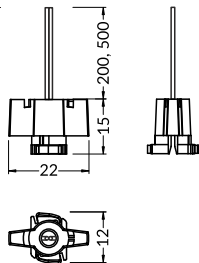

INDEX for 1 pc  
INDEKS = 1 szt

length	input voltage	max electric current	transparent
długość	napięcie	max natężenie	transparentny

200	12 V DC	5 A	94210000
500	12 V DC	5 A	94250000

### MIKRUS S flexible mounting plate

#### MIKRUS S uchwyt sprężysty

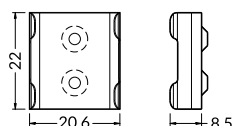

INDEX for 1 set  
1 set = 2 pcs  
INDEKS = 1 komplet  
1 komplet = 2 szt.

inox / inox 94230019

INDEX for 1 set  
package of 10 sets = 20 pcs  
INDEKS = 1 komplet  
opakowanie zawiera  
10 kompletów = 20 szt.

inox / inox 94240019

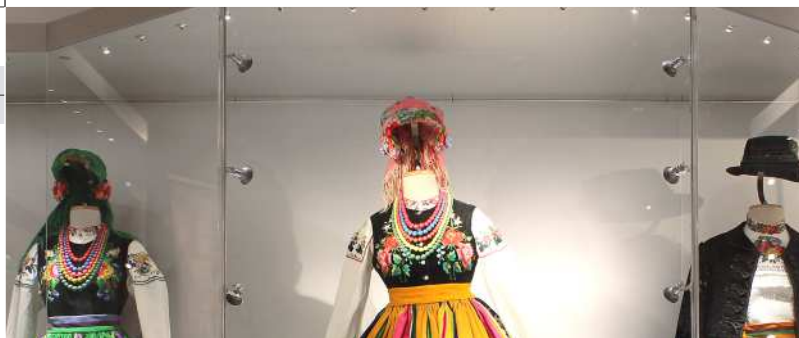

PL

Made in Poland  
Wyprodukowane w Polsce

 TOPMET®

TOPMET Light Kłósowicz Włósniewski i Wspólnik Sp. J. ADDRESS: Ostrowska 354, 61-312 Poznań, POLAND  
tel. +48 61 87 27 500, fax. +48 61 87 27 518 biuro@topmet.pl, www.topmet.pl

Depending on the type of lens used, the light flux of the entire luminaire can be smaller.  
Strumień świetlny całej oprawy może być mniejszy, w zależności od rodzaju zastosowanego klosza

The catalogue is not an offer under Polish Civil Code regulations. Colours of particular products may vary slightly from colours shown in pictures.  
The dimensions given are approximate and can not be a reason for complaint. TOPMET Company reserves the right to make technical changes.

Folder nie stanowi oferty w myśl przepisów Kodeksu Cywilnego. Aktualną ofertę firmy stanowi cennik. Kolory poszczególnych produktów mogą się nieznacznie różnić od kolorów prezentowanych na zdjęciach. Podane wymiary są wymiarami orientacyjnymi i nie mogą stanowić podstawy reklamacji. Firma TOPMET zastrzega sobie prawo do wprowadzania zmian technicznych.

brochure designer • proj. folderu: M. Kędziora, A. Szafran, 10.2016 photo • fot. K. Samulska, A. Szafran, L. Wesolowski